



# Item price list - Roller shutters

RS 53 RC 2



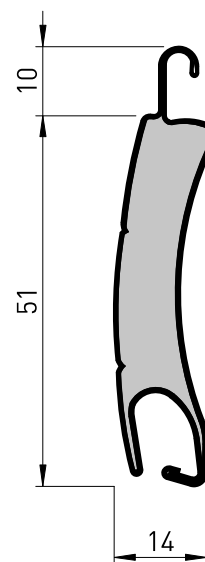

Standard roller shutter slats

Item designation	RS 53 RC 2	
Item no.	 766 ..	 767 ..
Sales unit content	5 x 6.5 m = 32.5 m	

Technical specifications	
Max. width [mm]	5,500
Max. height [mm]	4,000
Max. area [m <sup>2</sup> ]	16.5
Number of slats per 1 m curtain height [pc]	19
Finished curtain weight [kg/m <sup>2</sup> ]	10.5



1:1

 6	 7	 0.19 [m <sup>2</sup> K/W] (Class 5)	 RC 2	 ≤ 0.1 (Class 4)
Wind load resistance* according to EN 13659	Hail class**	Thermal insulation resistance ΔR according to EN 13125	Burglar resistant according to TR 111 BVRS	Total degree of energy transmission g <sub>tot</sub> according to DIN EN 14501:2005

\* For module width of 2,700 mm and a guide with 25 mm insertion depth.

\*\* Hail class in accordance with VKF (Swiss Association of Cantonal Fire Insurance Companies) Test Specifications No. 2.

### Wind resistance class according to DIN EN 13659

Component width [mm]	≤ 3,200	3,300	3,400	3,500	3,600	3,700	3,800	3,900	4,000	4,100	4,200	4,300	4,400	4,500	4,600	4,700	4,800	4,900	5,000	5,100	5,200	5,300	5,400	5,500
Guide rail depth 51 mm (H-STF V)	6	5	5	5	5	4	4	4	4	4	3	3	3	3	3	3	3	2	2	2	2	2	2	1

 » The test according to DIN EN 13659 allows the deviation of the max. use ranges from the previously applicable dimensions.

### Barrel diameter

Shaft	Curtain height [mm]	1,000	1,250	1,500	1,750	2,000	2,250	2,500	2,750	3,000	3,250	3,500	3,750	4,000
70-8k	Barrel diameter [mm]	159	168	182	196	209	218	230	241	242	255	268	273	284
	Panel size [mm]	180	205	205	205	230	230	254	254	254	-	-	-	-
125-8k	Barrel diameter [mm]	186	201	205	221	227	237	249	258	260	274	281	286	296
	Panel size [mm]	205	205	230	230	254	254	-	-	-	-	-	-	-

 » The barrel diameters were calculated with direct mounting.

# Item price list - Roller shutters

## RS 53 RC 2

## Standard roller shutter slats

Max. Component height (CH) RS 53 RC 2 with anti-push-up device [mm]		
Box height (BH)	Shaft 70-8k (a)	Shaft 125-8k (a)
100	-	-
125	-	-
137	-	-
150	-	-
165	-	-
180	1,180	-
205	1,800	1,300
230	2,330	2,030
254	3,050	2,550

Max. Component height (CH) RS 53 RC 2 with direct mounting [mm]		
Box height (BH)	Shaft 70-8k (a)	Shaft 125-8k (a)
100	-	-
125	-	-
137	-	-
150	-	-
165	-	-
180	1,180	-
205	1,900	1,300
230	2,500	2,030
254	3,150	2,550

Available colours				
Order no.	Name of colour	~ RAL	~ VSR	Discontinued colour

 766 ..	 767 ..			
... 17	traffic white	9016	-	-
... 18	grey	-	-	-
... 20	natural	9006	VSR 140	-
... 22	brown	-	-	-
... 23	creme	-	-	-
... 31	teak	-	-	•
... 32	light beige	-	-	-
... 39	RAL	-	-	-
... 52	black brown	-	-	-

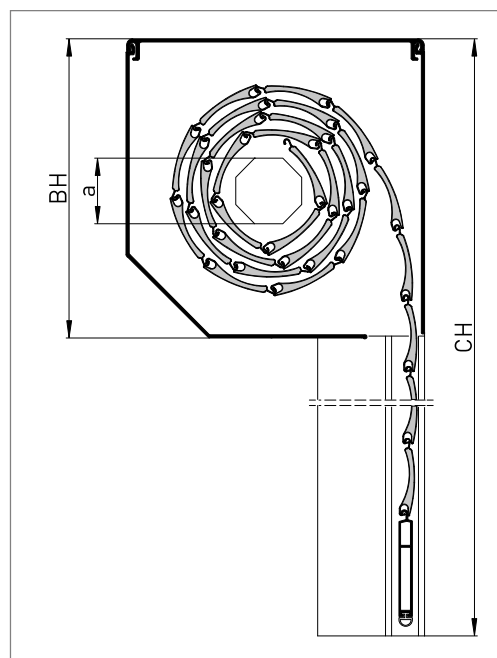

**i** » Please refer to the Service chapter for information on the quick connector that is compatible with the respective box height.